



# ZEISS Planar T\* 1.4/85



## Features

- Fast f/1.4 aperture
- Precise manual focusing
- Robust full-metal construction
- Fixation for focus and aperture
- Identical color reproduction of all models
- For industrial cameras with F-Mount up to sensor sizes of 24x36 mm or 43mm line sensors.

### **ZF-I: Industrial Edition**

Features special screws to fix focus and aperture settings even in rough situations.

### **ZF-IR: Infrared Edition**

Features special coating for optimized performance in near-infrared applications.

### **Camera Mounts**

Available with ZF.2, EF and M42 mount.



# ZEISS Planar T\* 1.4/85

## Technical Specifications

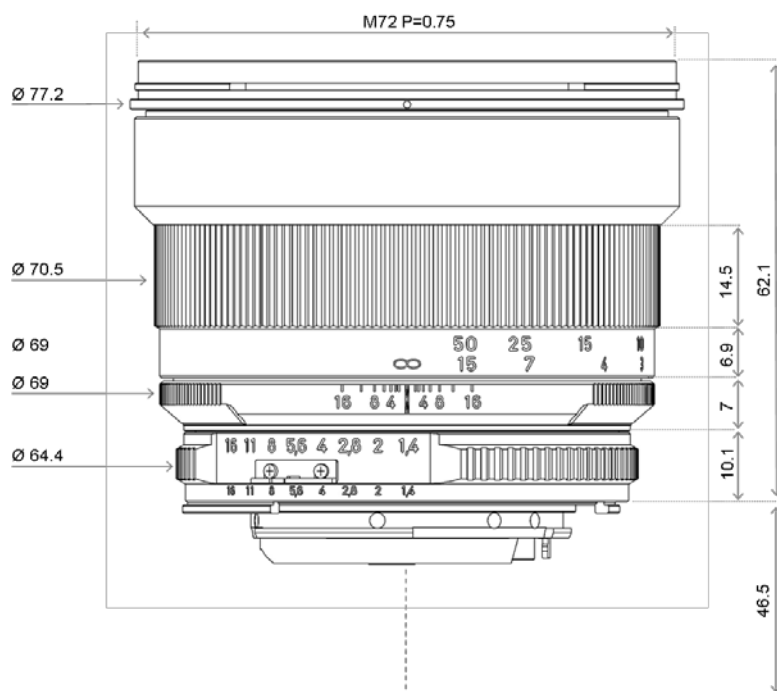

<b>Focal length</b>	85 mm
<b>Aperture range</b>	f/1.4 – f/16 (1/ 2 stop intervals)
<b>Number of elements / groups</b>	6 / 5
<b>Min. working distance (object to sensor)</b>	1000 mm (3.28 ft.) – $\infty$
<b>Min. free working distance</b>	883 mm (2.90 ft.) – $\infty$
<b>Angular field* (diag. / horiz. / vert.)</b>	29 / 24 / 16°
<b>Max. diameter of image field</b>	43 mm (1.7")
<b>Flange focal length</b>	F-Mount: 46.5 mm (1.8"); M42-Mount: 45,5 mm
<b>Coverage at close range</b>	240 x 360 mm (9.4 x 14"), line 430 mm (16.5")
<b>Image ratio at close range</b>	1:10
<b>Filter-thread</b>	M 72 x 0.75
<b>Weight</b>	600 g (1.2 lbs.)
<b>Camera mount</b>	F bayonet, M42, EF

\* referring to 35 mm format



# ZEISS Planar T\* 1.4/85

## Relative Illuminance\*

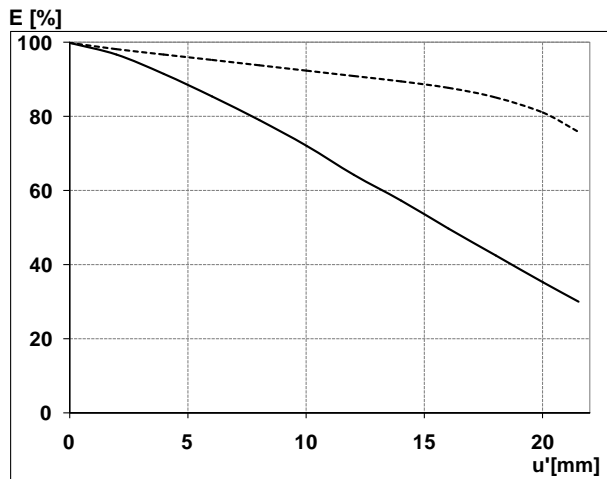

The relative illuminance shows the decrease in image brightness from the image center to the edge in percent.

— f-number 1.4  
... f-number 2.8

## Relative Distortion\*

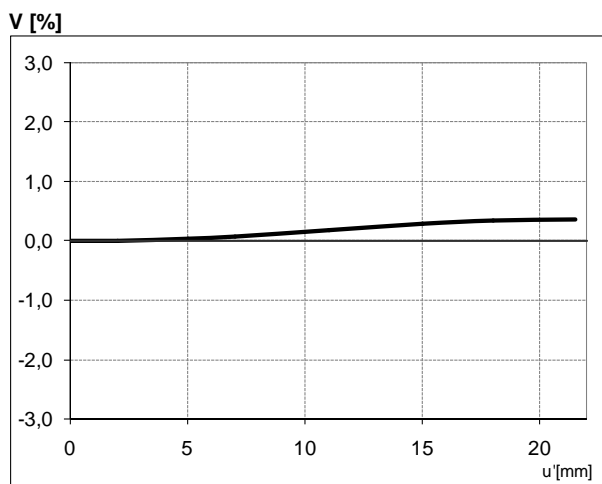

The relative distortion shows the deviation of the actual image height from the ideal one in percent.

\*Data for infinite focus setting



# ZEISS Planar T\* 1.4/85

## MTF Charts\*

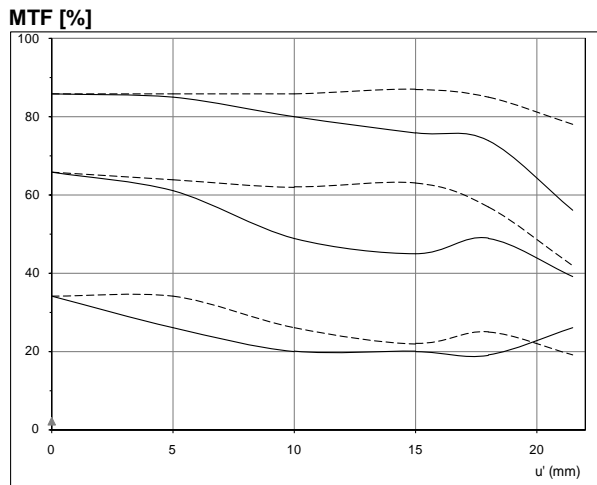

The Modulation Transfer (MTF) as a function of image height ( $u$ ) and slit orientation (sagittal, tangential) has been measured with white light at spatial frequencies of  $R = 10, 20$  and  $40$  cycles/mm. The MTF charts are valid for the ZF, ZF-I version and for white light.

f-number 1.4  
— Sagittal  
... Tangential

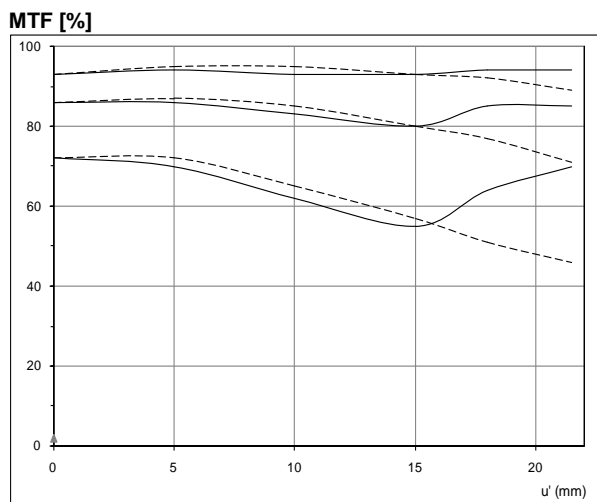

f-number 5.6  
— Sagittal  
... Tangential

\*Data for infinite focus setting / Not for IR version



# ZEISS Planar T\* 1.4/85

## Spectral Transmission ZF vs. ZF-IR

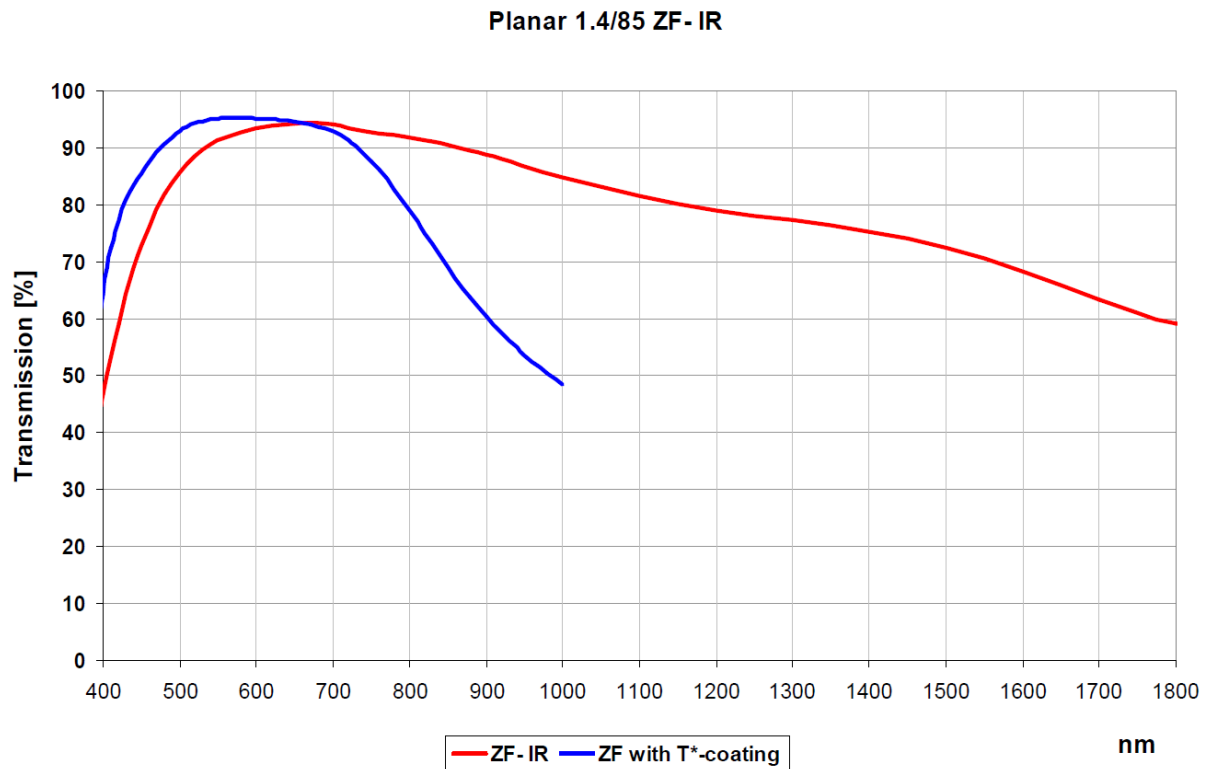



# ZEISS Planar T\* 1.4/85

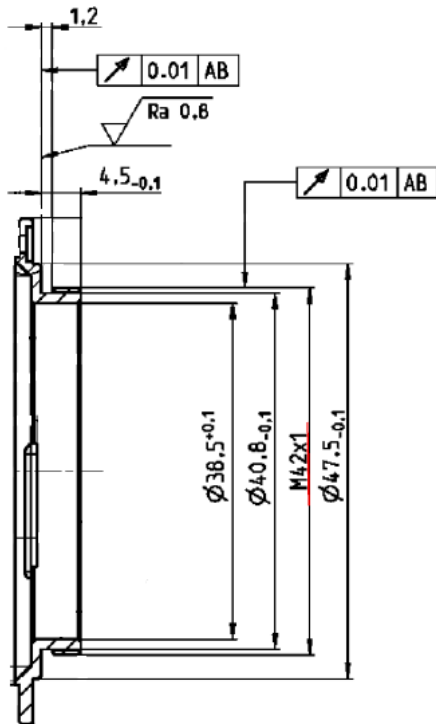

M42 Mount for 45,5 mm Flange Focal Distance

*The diameter of the camera/lens adapter must not exceed 55 mm at the lens side!*